

2-way, Characterized Control Valve, Chrome Plated Brass Ball and Nickel Plated Brass Stem



5-year warranty



Type overview

Type	DN
B207B	15

Technical data

Functional data	Valve size [mm]	0.5" [15]
	Fluid	chilled or hot water, up to 60% glycol
	Fluid Temp Range (water)	0...250°F [-18...120°C]
	Body Pressure Rating	600 psi
	Close-off pressure Δps	200 psi
	Flow characteristic	A-port equal percentage, B-port modified for constant common port flow
	Leakage rate	0% for A – AB
	Pipe connection	Internal thread NPT (female)
	Servicing	maintenance-free
	Flow Pattern	2-way
	Controllable flow range	75°
	Cv	0.3
	Materials	Valve body
Stem		nickel-plated brass
Stem seal		EPDM (lubricated)
Seat		PTFE
Characterized disc		TEFZEL®
O-ring		EPDM (lubricated)
Ball		chrome plated brass
Suitable actuators	Non Fail-Safe	TR LRB(X)
	Spring	TFRB(X) LF

Safety notes



- WARNING: This product can expose you to lead which is known to the State of California to cause cancer and reproductive harm. For more information go to www.p65warnings.ca.gov

Product features

Application This valve is typically used in air handling units on heating or cooling coils, and fan coil unit heating or cooling coils. Some other common applications include Unit Ventilators, VAV box re-heat coils and bypass loops. This valve is suitable for use in a hydronic system with variable flow.

Flow/Mounting details



Two-way valves should be installed with the disc upstream.

Dimensions

Type	DN	Weight
B207B	15	0.51 lb [0.23 kg]

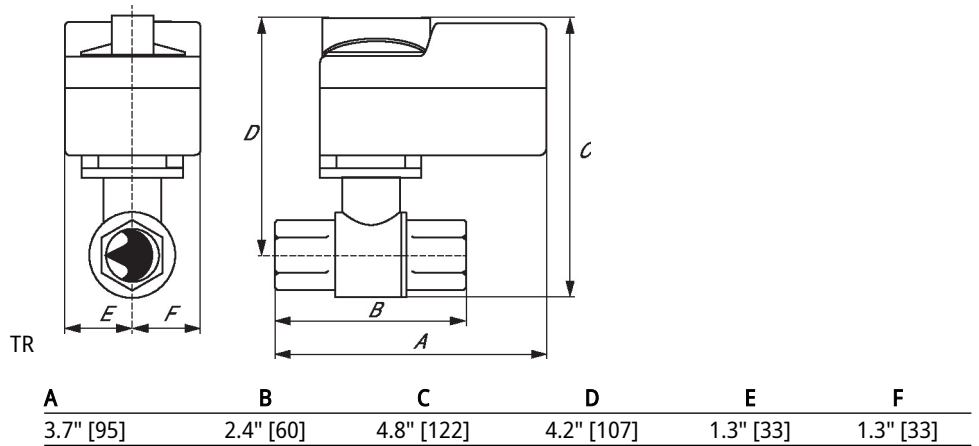
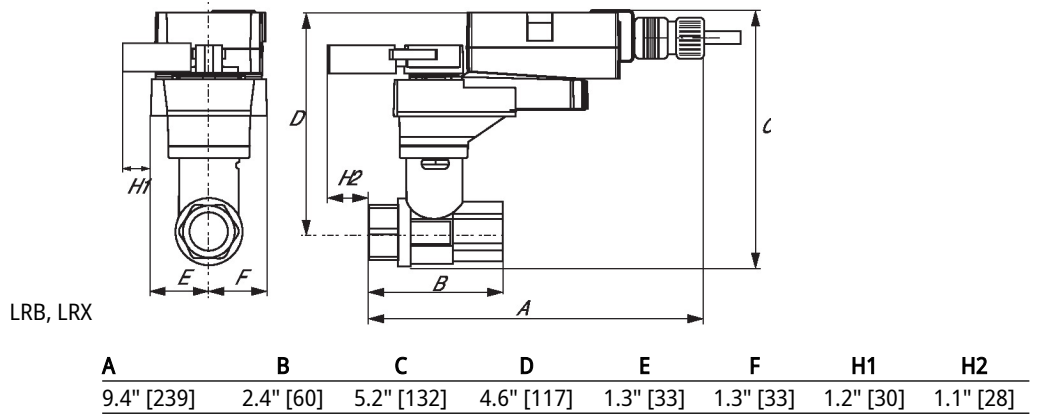

Dimensions

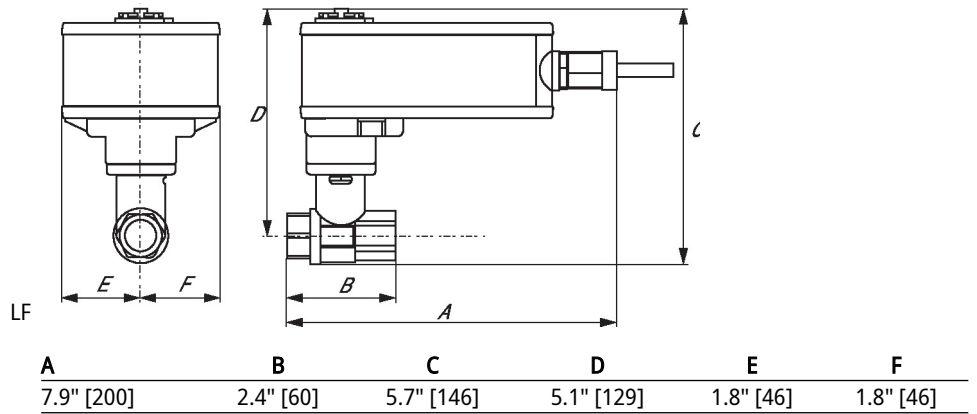

On/Off, Floating point, Non fail-safe, 24 V



5-year warranty

Technical data

Electrical data	Nominal voltage	AC/DC 24 V
	Nominal voltage frequency	50/60 Hz
	Nominal voltage range	AC 19.2...28.8 V / DC 21.6...28.8 V
	Power consumption in operation	1.5 W
	Power consumption in rest position	0.2 W
	Transformer sizing	2.5 VA
	Electrical Connection	Screw terminal (for 26 to 14 GA wire)
	Overload Protection	electronic throughout 0...90° rotation
	Electrical Protection	actuators are double insulated
Functional data	Direction of motion motor	selectable with switch 0/1
	Manual override	external push button
	Angle of rotation	90°
	Angle of rotation note	adjustable with mechanical stop
	Running Time (Motor)	90 s / 90°
	Noise level, motor	35 dB(A)
	Position indication	Mechanical, pluggable
	Safety data	Power source UL
Degree of protection IEC/EN		IP54
Degree of protection NEMA/UL		NEMA 1
Enclosure		UL Enclosure Type 1
Agency Listing		cULus acc. to UL60730-1A/-2-14, CAN/CSA E60730-1:02, CE acc. to 2014/30/EU
Quality Standard		ISO 9001
UL 2043 Compliant		Suitable for use in air plenums per Section 300.22(C) of the NEC and Section 602 of the IMC
Ambient humidity		Max. 95% RH, non-condensing
Ambient temperature		-22...122°F [-30...50°C]
Storage temperature		-40...176°F [-40...80°C]
Servicing		maintenance-free
Weight	Weight	1.6 lb [0.71 kg]
Materials	Housing material	Galvanized steel and plastic housing

Footnotes †Rated Impulse Voltage 800V, Type of Action 1, Control Pollution Degree 2.

Accessories

Electrical accessories	Description	Type
	Battery backup system, for non-spring return models	NSV24 US
	Battery, 12 V, 1.2 Ah (two required)	NSV-BAT
	Auxiliary switch 1x SPDT add-on	S1A
	Auxiliary switch 2x SPDT add-on	S2A
	Feedback potentiometer 140 Ω add-on, grey	P140A GR
	Feedback potentiometer 1 kΩ add-on, grey	P1000A GR
	Feedback potentiometer 10 kΩ add-on, grey	P10000A GR
	Feedback potentiometer 2.8 kΩ add-on, grey	P2800A GR
	Feedback potentiometer 500 Ω add-on, grey	P500A GR
	Feedback potentiometer 5 kΩ add-on, grey	P5000A GR

Electrical installation

⚡ INSTALLATION NOTES

- 1 Provide overload protection and disconnect as required.
- 2 Actuators may be connected in parallel. Power consumption and input impedance must be observed.
- 3 Actuators may also be powered by DC 24 V.
- 6 Actuators Hot wire must be connected to the control board common. Only connect common to neg. (-) leg of control circuits. Terminal models (-T) have no-feedback.
- 16 Actuators are provided with a numbered screw terminal strip instead of a cable.
- ◆ Meets cULus requirements without the need of an electrical ground connection.
- ⚠ **Warning! Live electrical components!**
During installation, testing, servicing and troubleshooting of this product, it may be necessary to work with live electrical components. Have a qualified licensed electrician or other individual who has been properly trained in handling live electrical components perform these tasks. Failure to follow all electrical safety precautions when exposed to live electrical components could result in death or serious injury.

Wiring diagrams

On/Off



Floating Point



Floating Point - Triac Source

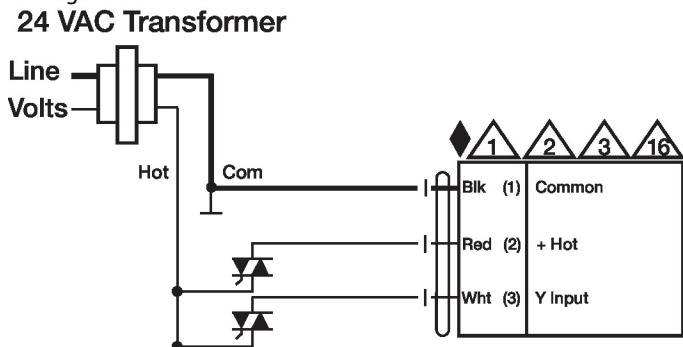

Floating Point - Triac Sink

