

3-way Mixing/Diverting, Characterized Control Valve, Stainless Steel Ball and Stem



5-year warranty



Type overview

Type	DN
B340	40

Technical data

Functional data	Valve size [mm]	1.5" [40]
	Fluid	chilled or hot water, up to 60% glycol
	Fluid Temp Range (water)	0...250°F [-18...120°C]
	Body Pressure Rating	400 psi
	Close-off pressure Δps	200 psi
	Flow	A-port: as stated in chart B-port: 70% of A – AB Cv
	Flow characteristic	A-port equal percentage, B-port modified for constant common port flow
	Leakage rate	0% for A – AB, <2.0% for B – AB
	Pipe connection	Internal thread NPT (female)
	Servicing	maintenance-free
	Flow Pattern	3-way Mixing/Diverting
	Controllable flow range	75°
	Cv	37
	Materials	Valve body
Stem		stainless steel
Stem seal		EPDM (lubricated)
Seat		PTFE
Characterized disc		stainless steel
O-ring		EPDM (lubricated)
Ball		stainless steel
Suitable actuators	Non Fail-Safe	ARB(X) ARQB(X) ARB(X) N4
	Spring	AFRB(X)

Safety notes



- **WARNING:** This product can expose you to lead which is known to the State of California to cause cancer and reproductive harm. For more information go to www.p65warnings.ca.gov

Product features

Application This valve is typically used in air handling units on heating or cooling coils, and fan coil unit heating or cooling coils. Some other common applications include Unit Ventilators, VAV box re-heat coils and bypass loops. This valve is suitable for use in a hydronic system with variable or constant flow.

Flow/Mounting details



Dimensions

Type	DN	Weight
B340	40	3.7 lb [1.7 kg]

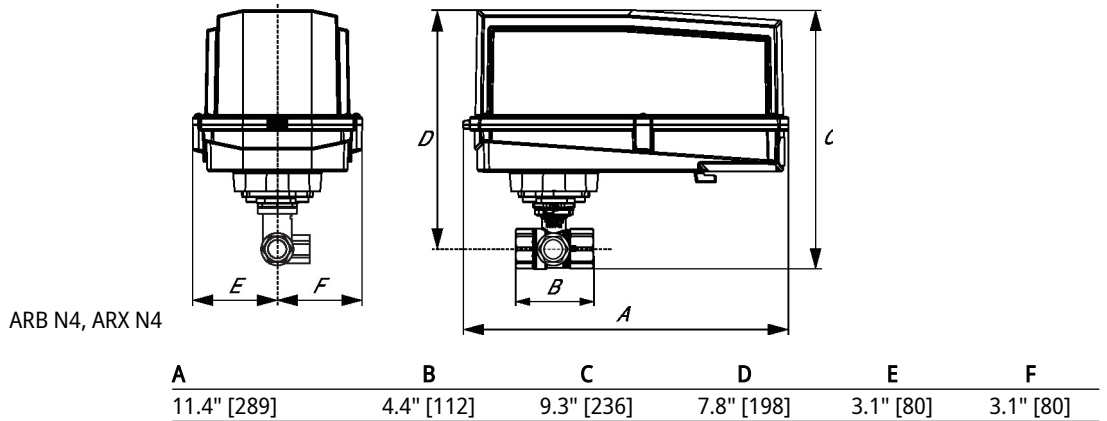

Dimensions

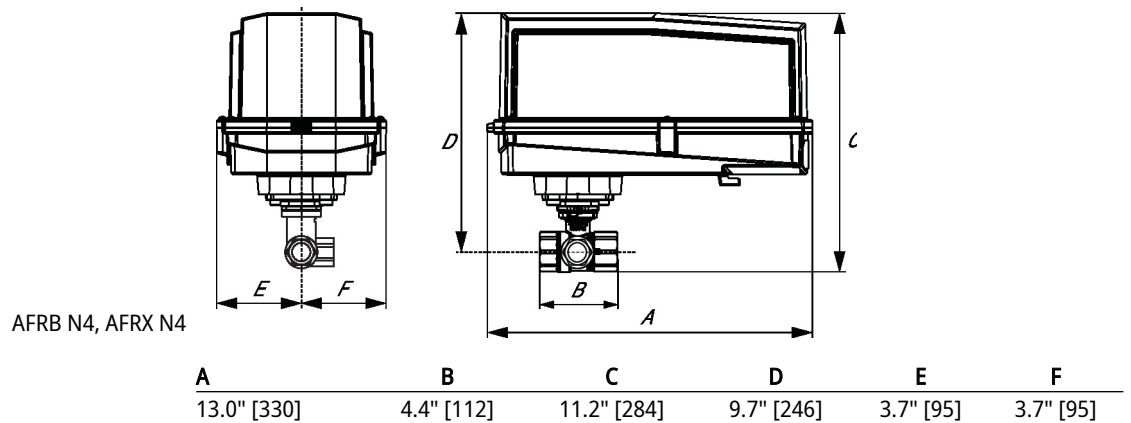
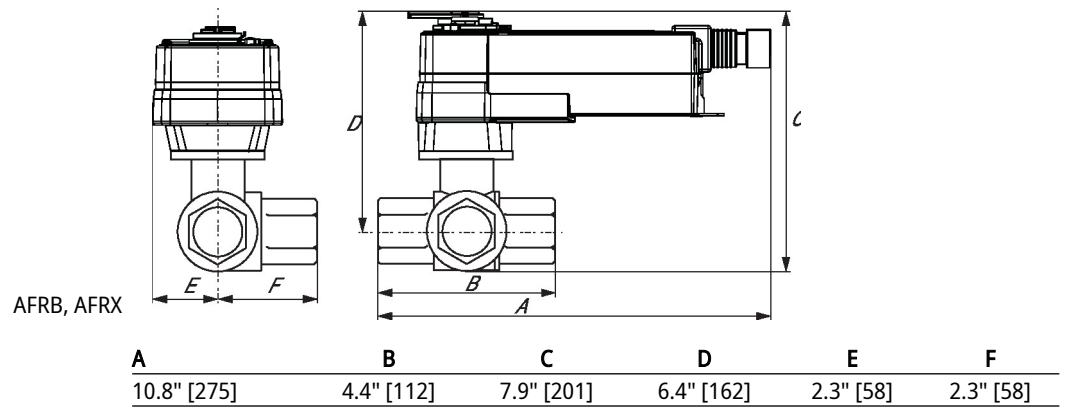
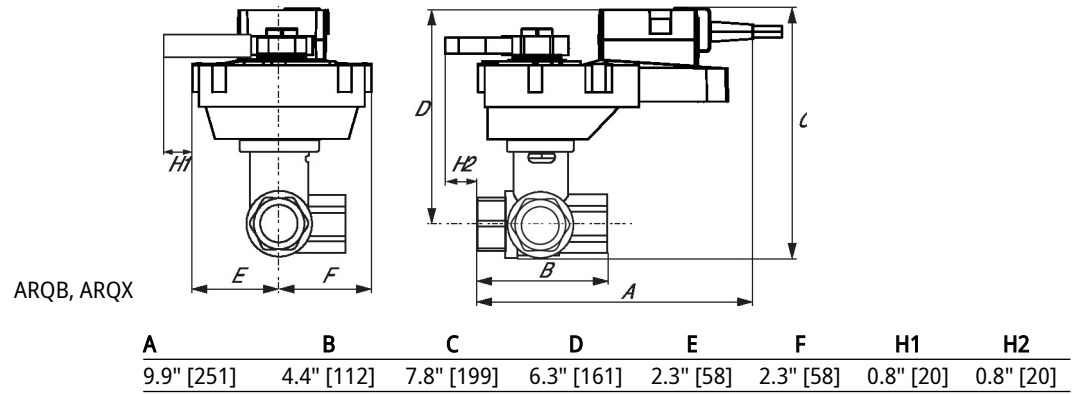



5-year warranty



Technical data

Electrical data	Nominal voltage	AC/DC 24 V	
	Nominal voltage frequency	50/60 Hz	
	Nominal voltage range	AC 19.2...28.8 V / DC 21.6...28.8 V	
	Power consumption in operation	2.5 W	
	Power consumption in rest position	0.4 W	
	Transformer sizing	5 VA	
	Electrical Connection	18 GA plenum cable with 1/2" NPT conduit connector, degree of protection NEMA 2 / IP54, 1 m 3 m and 5 m	
	Overload Protection	electronic throughout 0...90° rotation	
Functional data	Operating range Y	2...10 V	
	Operating range Y note	4...20 mA w/ ZG-R01 (500 Ω, 1/4 W resistor)	
	Input impedance	100 kΩ for 2...10 V (0.1 mA), 500 Ω for 4...20 mA	
	Position feedback U	2...10 V	
	Position feedback U note	Max. 1 mA	
	Direction of motion motor	selectable with switch 0/1	
	Manual override	external push button	
	Angle of rotation	90°	
	Angle of rotation note	adjustable with mechanical stop	
	Running Time (Motor)	90 s / 90°	
	Running time motor variable	90 or 150 s	
	Noise level, motor	45 dB(A)	
	Position indication	Mechanical, pluggable	
	Safety data	Power source UL	Class 2 Supply
Degree of protection IEC/EN		IP54	
Degree of protection NEMA/UL		NEMA 2	
Enclosure		UL Enclosure Type 2	
Agency Listing		cULus acc. to UL60730-1A/-2-14, CAN/CSA E60730-1:02, CE acc. to 2014/30/EU	
Quality Standard		ISO 9001	
UL 2043 Compliant		Suitable for use in air plenums per Section 300.22(C) of the NEC and Section 602 of the IMC	
Ambient humidity		Max. 95% RH, non-condensing	
Ambient temperature		-22...122°F [-30...50°C]	
Storage temperature		-40...176°F [-40...80°C]	
Servicing		maintenance-free	
Weight		Weight	2.0 lb [0.90 kg]
		Materials	Housing material Galvanized steel and plastic housing

Footnotes †Rated Impulse Voltage 800 V, Type action 1, Control Pollution Degree 3.

Accessories

Electrical accessories	Description	Type
	Battery backup system, for non-spring return models	NSV24 US
	Battery, 12 V, 1.2 Ah (two required)	NSV-BAT

Electrical installation

INSTALLATION NOTES

- Provide overload protection and disconnect as required.
- Actuators may be connected in parallel. Power consumption and input impedance must be observed.
- Actuators may also be powered by DC 24 V.
- Only connect common to negative (-) leg of control circuits.
- A 500 Ω resistor (ZG-R01) converts the 4...20 mA control signal to 2...10 V.
- Actuators with plenum cable do not have numbers; use color codes instead.
- Meets cULus requirements without the need of an electrical ground connection.
- Warning! Live electrical components!**
During installation, testing, servicing and troubleshooting of this product, it may be necessary to work with live electrical components. Have a qualified licensed electrician or other individual who has been properly trained in handling live electrical components perform these tasks. Failure to follow all electrical safety precautions when exposed to live electrical components could result in death or serious injury.

Wiring diagrams

2...10 V / 4...20 mA Control

